

ICBDD30**FEATURES**

Rigorously tested for decades of use

Exceptional support from our Customer Care team

Lowers when not in use

Heavy-gauge stainless steel

Delay-off feature

Delay-off feature shuts off blower after approximately 5 minutes

Reversible motor box can be installed on either side of the downdraft

Adjustable discharge lets you negotiate around ducting

Blower required (internal blower available)

Remote control operation from up to 3 m away

Rises 356 mm to whisk away smoke and odours

ACCESSORIES

Trim kit for installation with sealed burner rangetop

Make-up air damper

Accessories available through an authorized dealer.

For local dealer information, visit subzero-wolf.com/locator.

**BLOWER OPTIONS**

- 900 CMH Internal Blower

PRODUCT SPECIFICATIONS

Model	ICBDD30
Dimensions	762mmW x 356mmH x 51mmD
Weight	34 kg
Electrical Supply	220-240 VAC; 50/60 Hz
Electrical Service	≤ 6 A
Discharge Location	Vertical or Horizontal
Discharge Dimensions	150 mm round internal or 250 mm round remote
Receptacle	3-prong grounding-type

ELECTRICAL

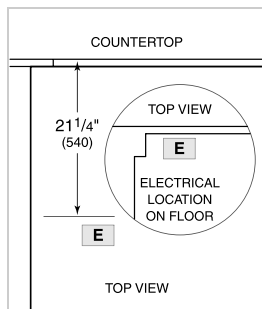

NOTE: Dimensions in parenthesis are in millimeters unless otherwise specified

DIMENSIONS

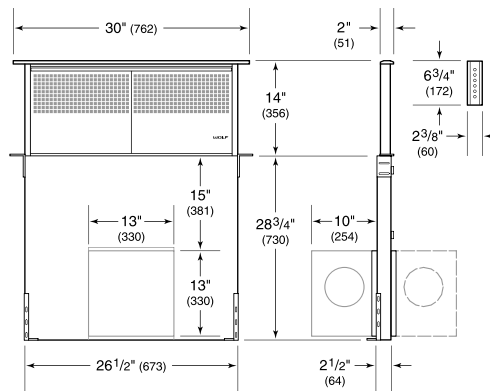

NOTE: Shown with front mounted internal blower with 6" (152) round discharge, dashed line represents rear mount.

STANDARD INSTALLATION

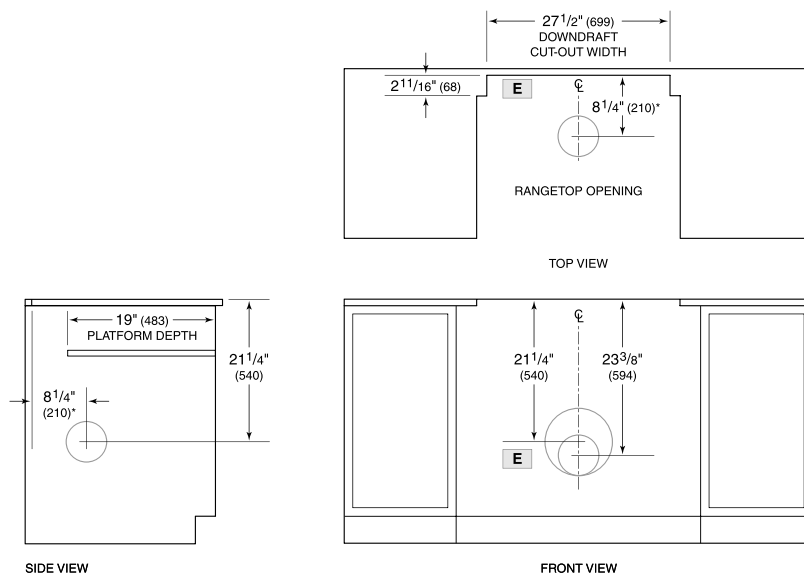

*6" (152) back from countertop cut-out when internal blower is rear mounted.

NOTE: Internal blower 6" (152) round, side, rear or bottom discharge. In-line and remote blower 10" (254) round, rear discharge. Centerline indicates center of downdraft cut-out.